

# TRIUMPH BONNEVILLE SPEEDMASTER '18-

## M O U N T I N G I N S T R U C T I O N S

REF 21116

SEMIFAIRING BATWING SML SPORT MODEL

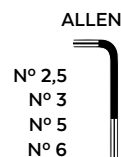

En las revisiones del vehículo es conveniente efectuar también el mantenimiento de apriete de toda la tornillería del semicarenado, especialmente los tornillos que fijan éste al vehículo. **Gracias por su atención.**  
It would be convenient to retight the semifairing screws, specially the ones that are fixed to the motorcycle, whenever you maintain the vehicle. **Thanks for your attention.**

ID.	PIEZA/PART	DESCRIPCIÓN	DESCRIPTION	QTY.	REF.:
1		Semicarenado BATWING SML	BATWING SML semifairing	1	10897NM3
2		Cúpula Sport	Sport screen	1	10899H/WM3
3		Soporte Derecho Superior (R)	Upper Right support (R)	1	SOP4P2-SR-21116
4		Soporte izquierdo Superior (L)	Upper Left support (L)	1	SOP4P2-SL-21116
5		Soporte Derecho Inferior (R)	Lower Right support (R)	1	SOP4P2-IR-21116
6		Soporte izquierdo Inferior (L)	Lower Left support (L)	1	SOP4P2-IL-21116
7		Tornillo Allen M8x45 DIN912	M8x45 DIN912 allen screw	2	TORNI-AD912-508
8		Casquillo Ø8,5xØ13x15	Ø8,5xØ13x15 arrowhead	2	CASQUI-M----614
9		Tornillo Allen M6X35 DIN912	M6X35 DIN912 allen screw	2	TORNI-D912--447
10		Casquillo Ø8,5xØ13x12	Ø8,5xØ13x12 arrowhead	2	CASQUI-M----769
11		Silentblock M5	M5 silentblock	4	SILENBTM5-046/1
12		Arandela nylon M5x1	M5x1 nylon washer	4	ARNV00000000245
13		Tornillo allen M5x16 Ø11 ISO 7380	M5x16 Ø11 ISO 7380 allen screw	4	TORNI-I7380-493
14		Tapón tornillo M5 ISO 7380	M5 ISO 7380 screw cap	4	TAPON-----85
15		Tapón tuerca M4	M4 nut cap	3	TAPON-----91
16		Tuerca grafilada M4	M4 nut	3	TUERCAE985-0290
17		Arandela nylon M4	M4 nylon washer	6	ARNV00000000311
18		Tornillo allen M4x12 ISO 7380	M4x12 ISO 7380 allen screw	3	TORNI-I7380-800

# TRIUMPH BONNEVILLE SPEEDMASTER '18-

INSTRUCCIONES DE MONTAJE - MOUNTING INSTRUCTIONS - MONTAGEANLEITUNG

**1**

DISASSEMBLY  
DESMONTAJE

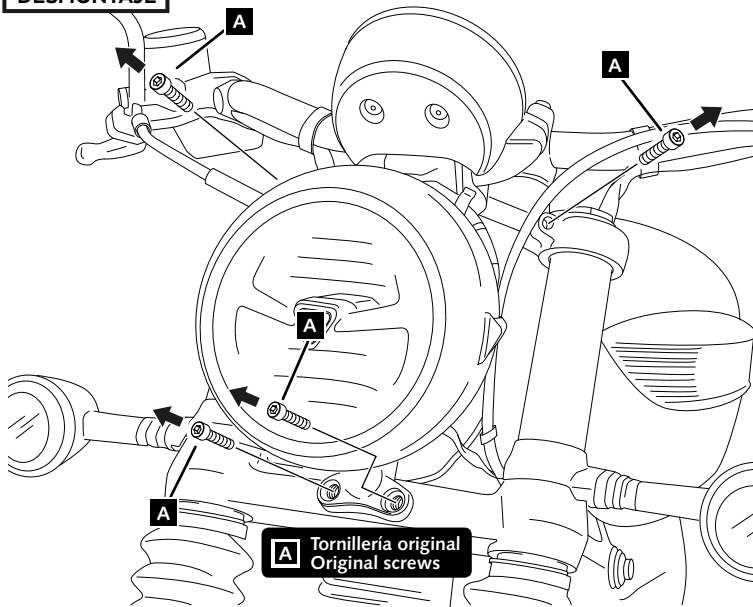

- NO EXTRAER LOS TORNILLOS A LA VEZ.  
REALIZAR EL MONTAJE DE LOS SOPORTES UNO POR UNO.

- DO NOT REMOVE THE SCREWS AT THE SAME TIME.  
MOUNT THE SUPPORTS ONE BY ONE.

**2**

ASSEMBLY  
MONTAJE

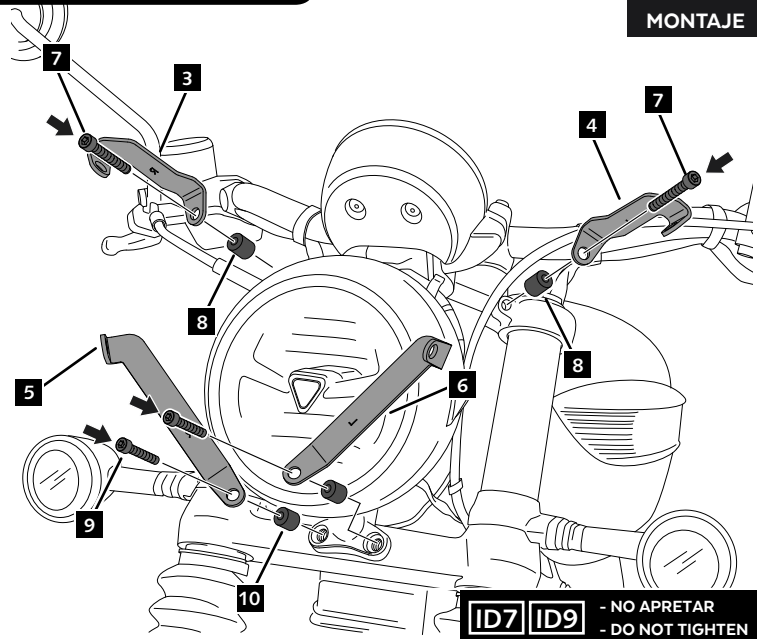

**3**

ASSEMBLY  
MONTAJE

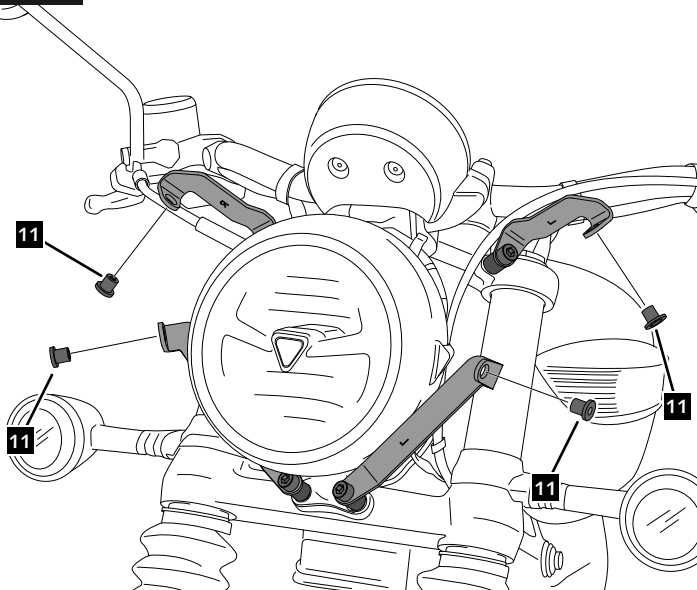

**4**

ASSEMBLY  
MONTAJE

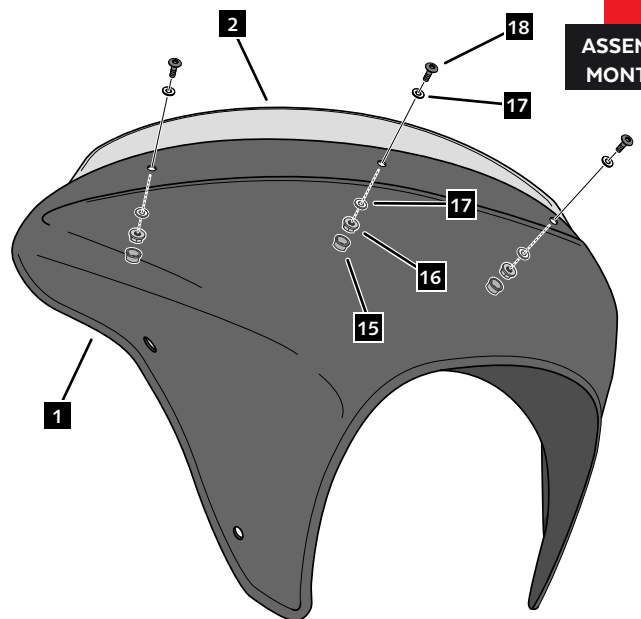

# TRIUMPH BONNEVILLE SPEEDMASTER '18-

INSTRUCCIONES DE MONTAJE - MOUNTING INSTRUCTIONS - MONTAGEANLEITUNG

**5**

ASSEMBLY  
MONTAJE

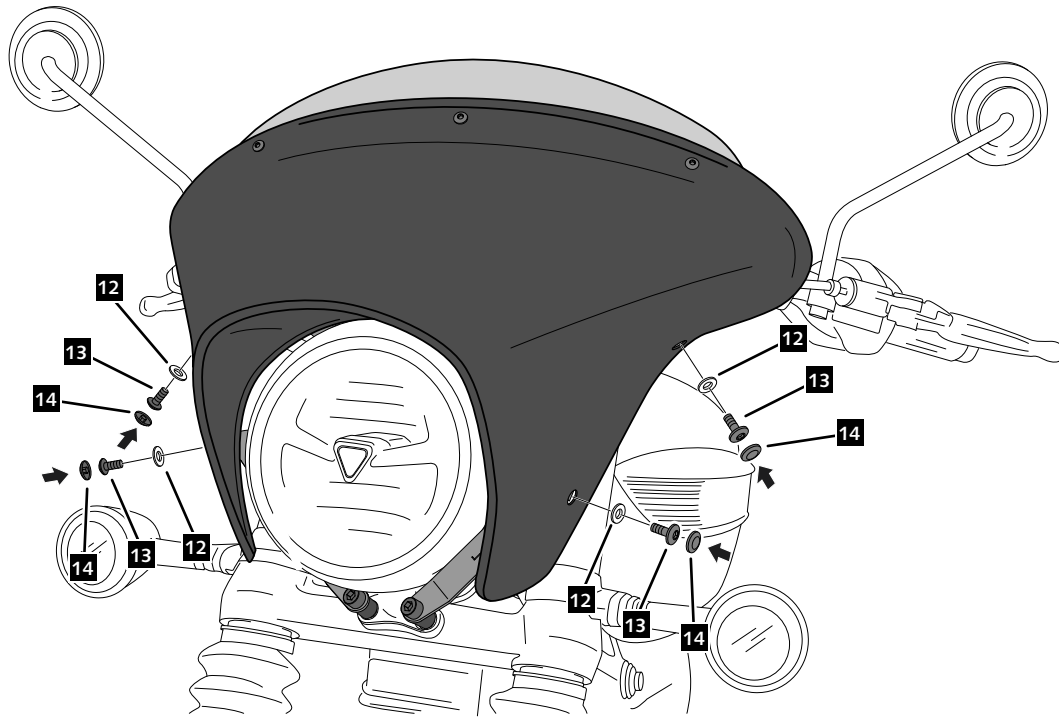

**6**

ASSEMBLY  
MONTAJE

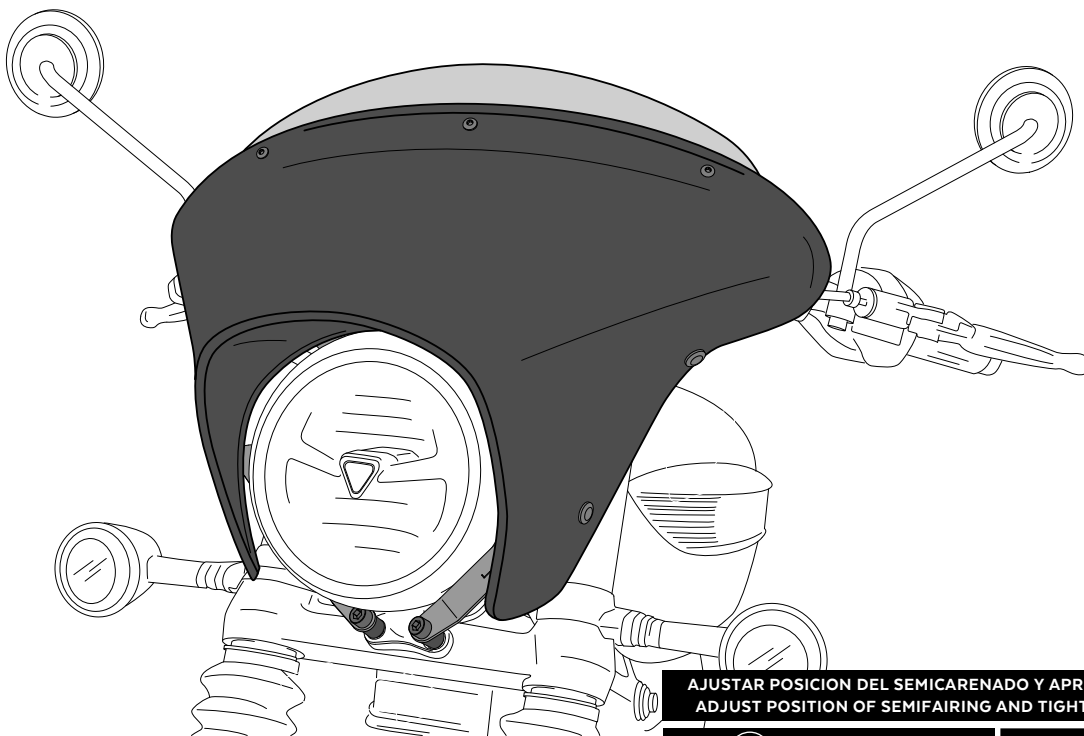

AJUSTAR POSICIÓN DEL SEMICARENADO Y APRETAR TORNILLOS ID7 Y ID9  
ADJUST POSITION OF SEMIFAIRING AND TIGHTEN ID7 AND ID9 SCREWS



25 Nm - Par de apriete  
25 Nm - Tightening torque



9 Nm - Par de apriete  
9 Nm - Tightening torque