

MOTOPLASTIC, S.A.

Molí de la sal, 1 - 08400 Granollers (Barcelona) SPAIN

Tel. 34 93 849 06 33 - Fax 34 93 849 09 88

info@puig.tv - info@puigusa.com

www.puig.tv - www.puigusa.com



INSTRUCCIONES DE MONTAJE - MOUNTING INSTRUCTIONS

VISERA PARA EVITAR EL "EFECTO LUPA" DE LA CÚPULA
 PLATE TO AVOID "GLASS EFFECT" OF THE SCREEN

HONDA CBR1000RR '04-'07

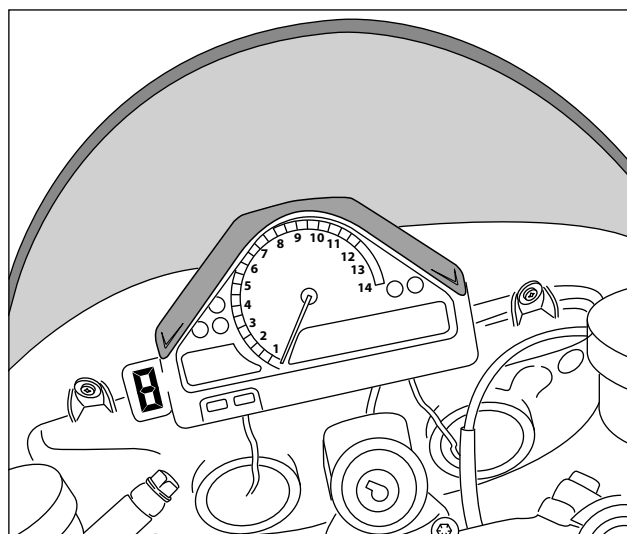
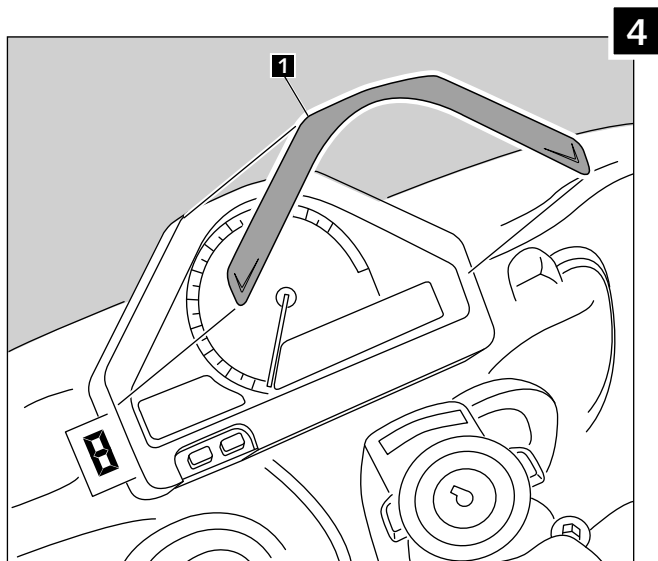
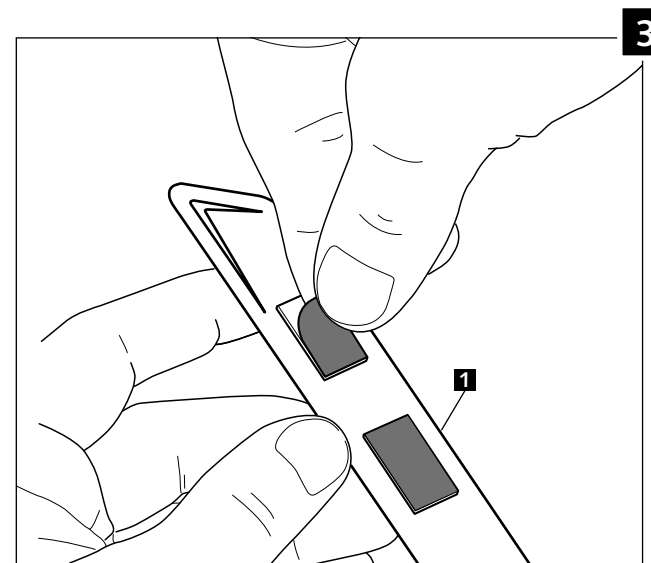
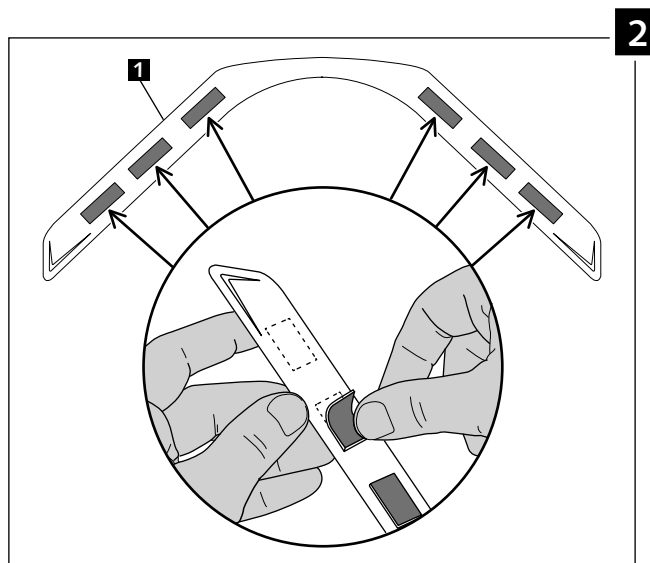
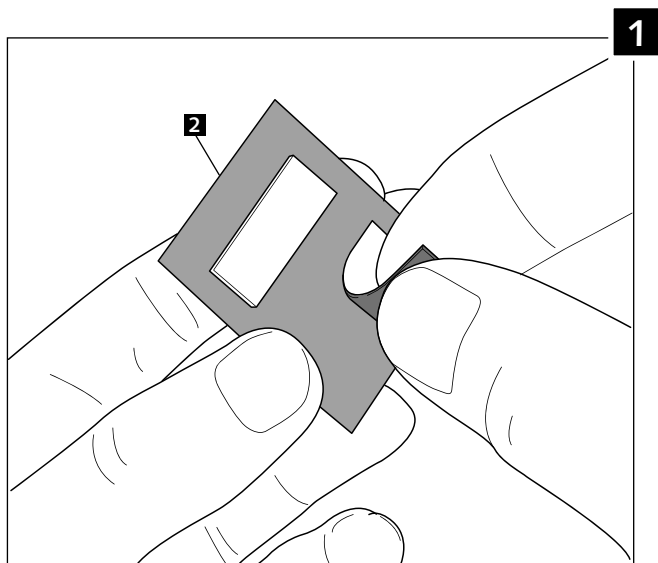
Ref.: 1665

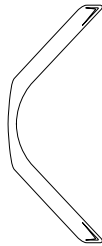

ID.	DESCRIPCIÓN / DESCRIPTION	QTY.
1	 Visera Plate	1
2	 Tira autoadhesiva de 2 unidades: Adhesive strips 2 units: 14mm x 7mm	3