

QUILLA ADAPTABLE A – ENGINE SPOILER FOR – BUGSPOILER FÜR
SUZUKI SV650 '99-'12 - DL650 V-STROM '04-'11
SUZUKI SV650 '16













Ref.: 8559J
 (color negro/black colour)

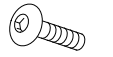

Ref.: 8559C
 (color carbono/carbon look)



ID.		DESCRIPCIÓN	DESCRIPTION	QTY.
1		Quilla	Engine spoiler	1
2		Soporte anterior izquierdo	Front left support	1
3		Soporte anterior derecho	Front right support	1
4.1		Soporte posterior izquierdo (SUZUKI SV650 '99-'12 / SUZUKI V-STROM '04-'11)	Rear left support (SUZUKI SV650 '99-'12 / SUZUKI V-STROM '04-'11)	1
4.2		Soporte posterior izquierdo (SUZUKI SV650'16)	Rear left support (SUZUKI SV650 '16)	1
5		Soporte posterior derecho	Rear right support	1
6		Tuerca enjaulada de aluminio M6	M6 aluminum lock nut	5
7		Tornillo Allen M6x20 ISO7380	M6x20 ISO7380 allen screw	4
8		Silemblock Ø9Ø11xØ18 (se suministra montado en la pieza1)	Ø9Ø11xØ18 well nut (supplied already manted on the 1 piece)	4
9		Casquillo con valona (se suministra montado en la pieza 1)	Arrowhead with valona (supplied already manted on the 1 piece)	4
10		Tapón tornillo M6	M5 screw cap	4
11		Kit adhesivos	Stickers set	4

QUILLA ADAPTABLE A – ENGINE SPOILER FOR – BUGSPOILER FÜR

SUZUKI SV650 '99-'12 - DL650 V-STROM '04-'11 SUZUKI SV650 '16

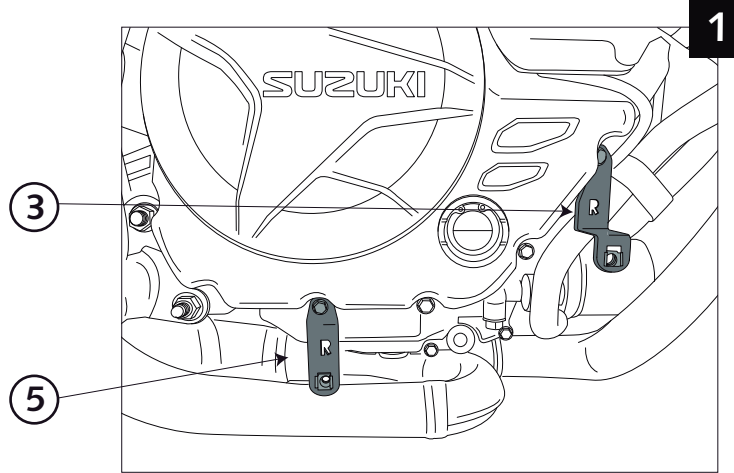

Soporte anterior y posterior,
 parte derecha.
 Front and rear right supports.

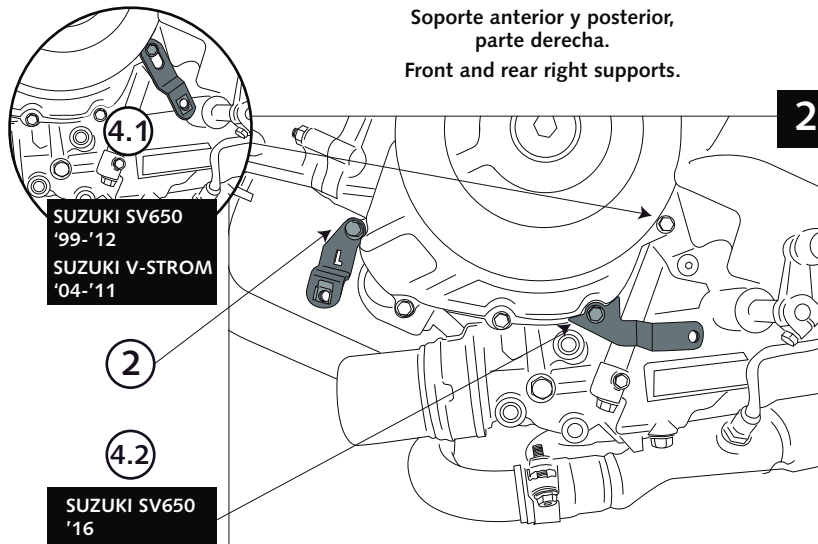

SUZUKI SV650
 '99-'12
 SUZUKI V-STROM
 '04-'11

SUZUKI SV650
 '16

Soportes anterior y posterior,
 parte izquierda.
 Front and rear left supports.

