

YAMAHA MT-09 '17-

M O U N T I N G I N S T R U C T I O N S

REF 20380

NAKED SPOILERS



1 Person



45 min



DIFFICULT



FIX



N° 10
N° 11

FLAT
SCREWDRIVER



ALLEN



N° 3
N° 4

ID.	PIEZA/PART	DESCRIPCIÓN	DESCRIPTION	QTY.	REF.:
1		Deflector	Deflector	2	10787N /A/R/VM3
2		Aleron superior derecho	Right superior spoiler	1	10782M3
3		Aleron inferior derecho	Right inferior spoiler	1	10782M3
4		Aleron superior izquierdo	Left superior spoiler	1	10782M3
5		Aleron inferior izquierdo	Left inferior spoiler	1	10782M3
6		Soporte derecho	Right support	1	SOPOR8P5R20380
7		Soporte izquierdo	Left support	1	SOPOR8P5L20380
8		Soporte intermitente derecho	Right turn light support	1	SOPOR8P5RTL20380
9		Soporte intermitente izquierdo	Left turn light support	1	SOPOR8P5LTL20380
10		Pletina intermitente	Turn light plate	2	SOPOR8P5P20380
11		Tapeta intermitente	Turn light cover	2	SOPOR8P5C20380
12		Tornillo especial M5x16 long hexagonal 40 (Rosca interior M5x15)	M5x16 long hexagonal 40 (Rosca interior M5x15) special screw	2	TORNI-E-----859
13		Casquillo Ø8,5xØ13x3,5mm	Ø8,5xØ13x3,5 spacer	2	CASQUI-----775
14		Tornillo allen M5x16 Ø11 ISO 7380	M5x16 Ø11 ISO 7380 Allen screw	4	TORNI-I780-493
15		Tornillo allen M5x11 Ø11 ISO 7380	M5x11 Ø11 ISO 7380 Allen screw	14	TORNI-AI-----520
16		Arandela nylon M5X1	M5X1 nylon washer	12	ARNV0000000245
17		Tapón tornillo M5 ISO 7380	M5 ISO 7380 allen screw cap	14	TAPON-----85
18		Silentblock M5	M5 Silentblock	4	SILENTBTM5-046/1

YAMAHA MT-09 '17-

INSTRUCCIONES DE MONTAJE - MOUNTING INSTRUCTIONS - MONTAGEANLEITUNG

Se muestra el montaje del lado derecho a modo de ejemplo, realizar los mismos pasos para el montaje del lado izquierdo.
The right side assembly is shown as an example, so the same steps can be performed for the left side assembly.

1

A Tornillería original
Original screws

DISASSEMBLY
DESMONTAJE

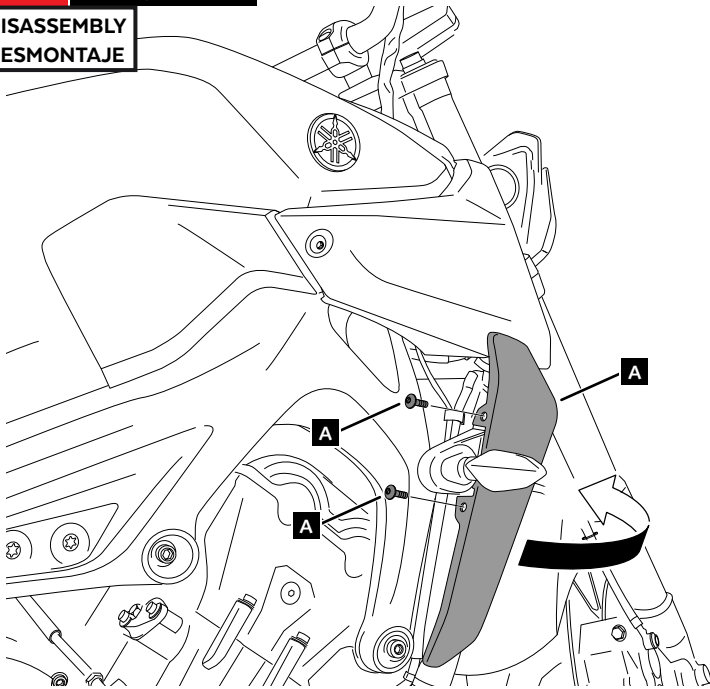

2

A Tornillería original
Original screws

DISASSEMBLY
DESMONTAJE

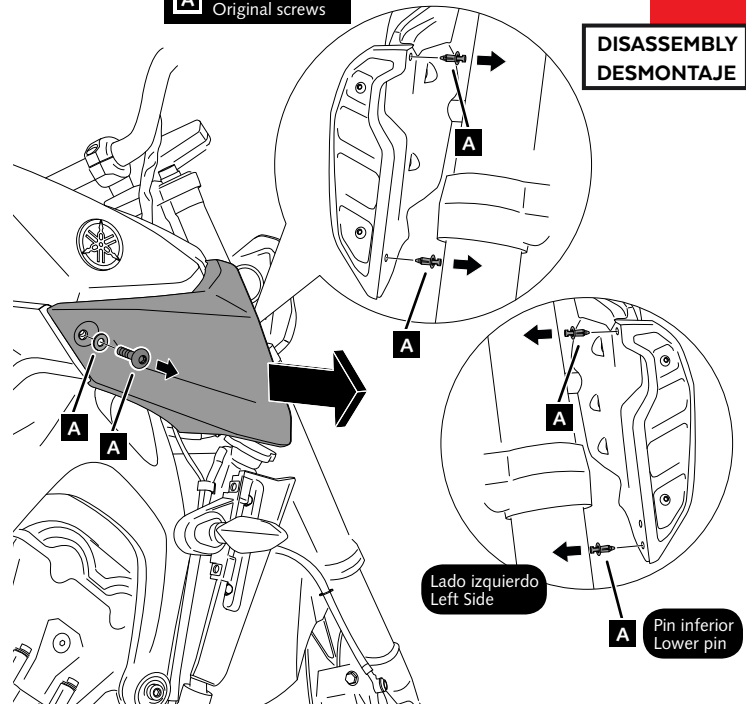

3

A Tornillería original
Original screws

⚠ Buscar conector
intermitente original
Search original turn
signal connector

DISASSEMBLY
DESMONTAJE

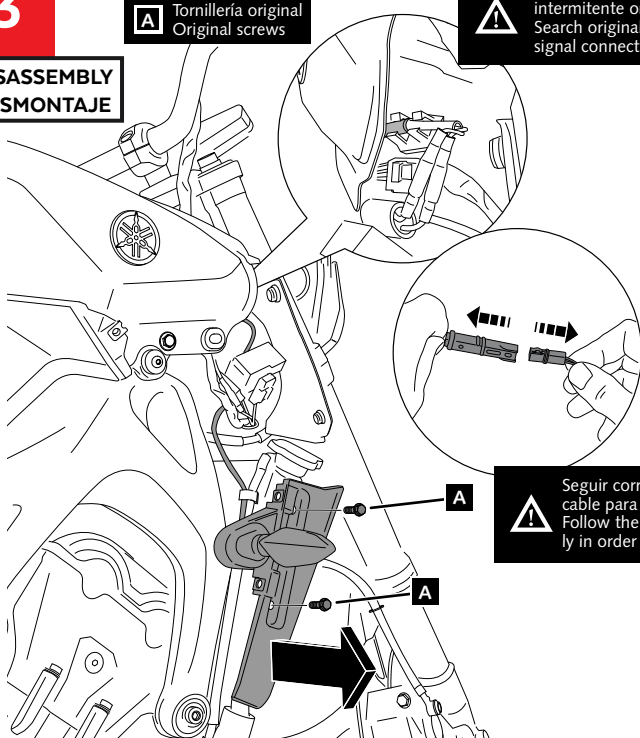

⚠ Seguir correctamente el
cable para desmontarlo
Follow the wire correct-
ly in order to remove it

4

A Tornillería original
Original screws

ASSEMBLY
MONTAJE

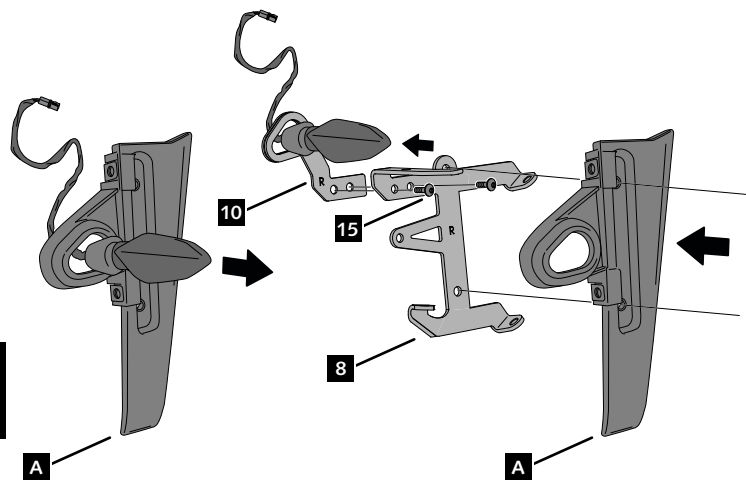

MONTAJE CONJUNTO (VER PÁG.3)
MOUNTING SET (VIEW P.3)

YAMAHA MT-09 '17-

INSTRUCCIONES DE MONTAJE - MOUNTING INSTRUCTIONS - MONTAGEANLEITUNG

5

DESAMONTAJE INTERMITENTE ORIGINAL
DISASSEMBLE ORIGINAL TURN SIGNAL

DISASSEMBLY
DESMONTAJE

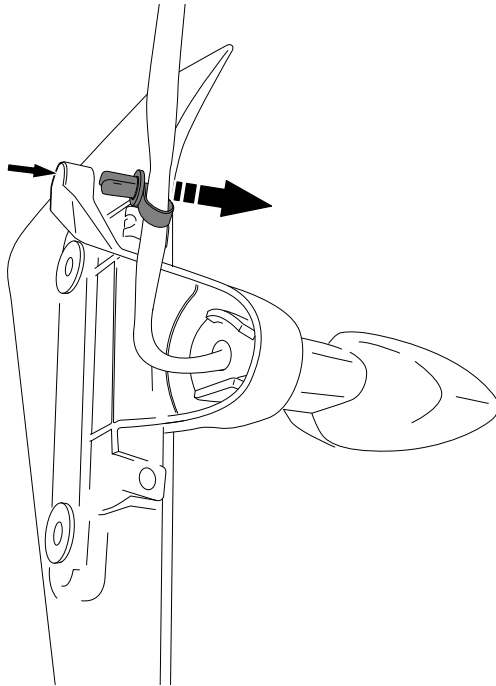

6

DISASSEMBLY
DESMONTAJE

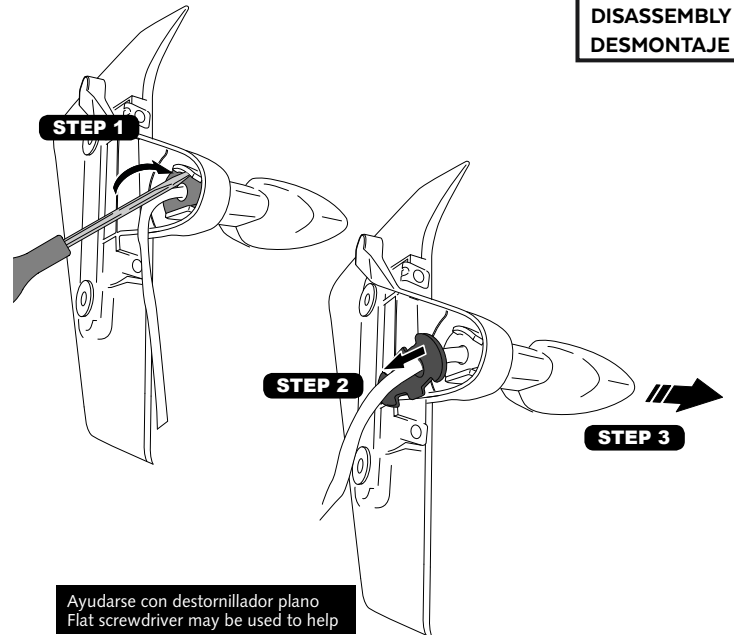

7

A Intermitente original
Original turn signal

ASSEMBLY
MONTAJE

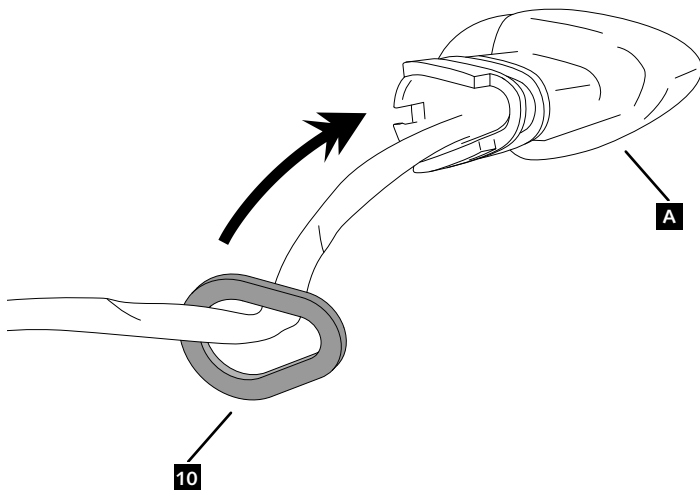

8

ASSEMBLY
MONTAJE

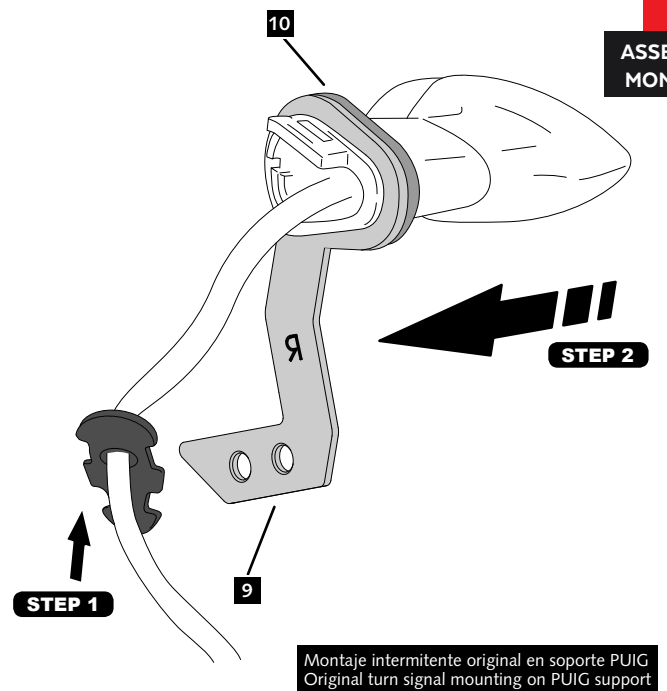

YAMAHA MT-09 '17-

INSTRUCCIONES DE MONTAJE - MOUNTING INSTRUCTIONS - MONTAGEANLEITUNG

9

ASSEMBLY
MONTAJE

A Tornillería original
Original screws

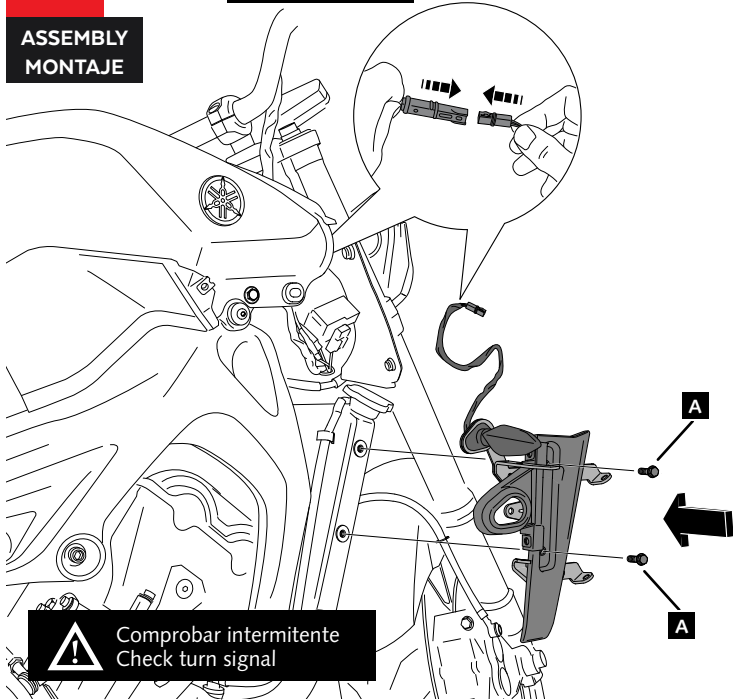

10

ASSEMBLY
MONTAJE

A Tornillería original
Original screws

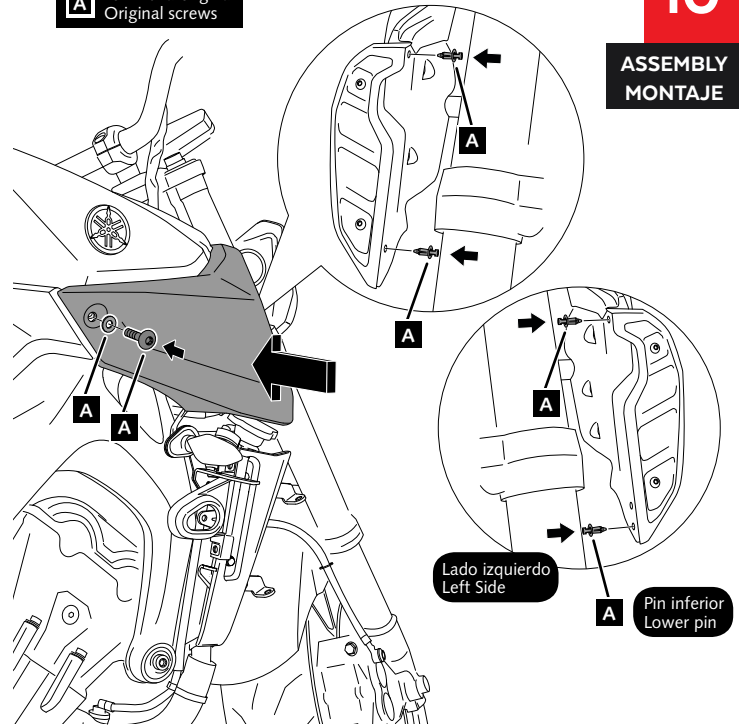

11

ASSEMBLY
MONTAJE

A Tornillería original
Original screws

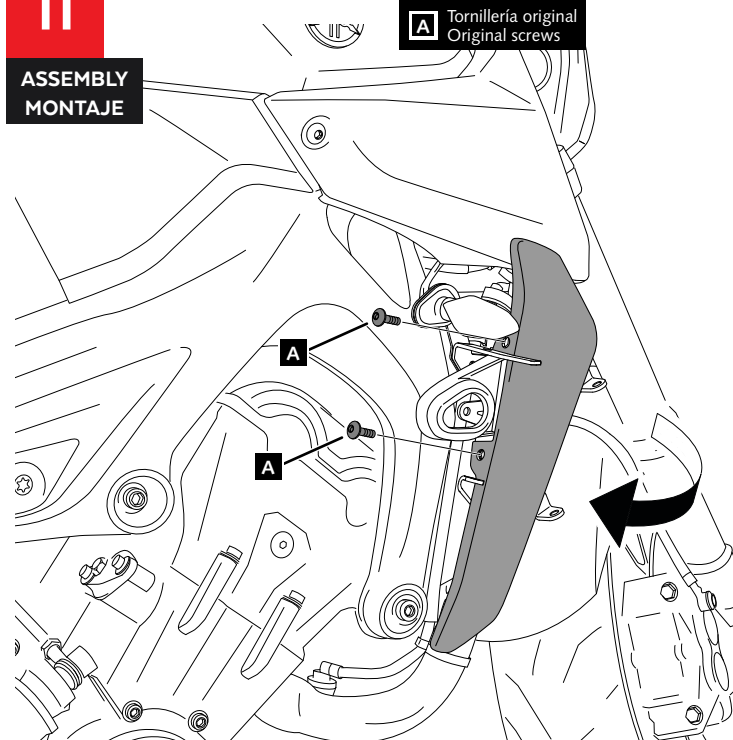

12

ASSEMBLY
MONTAJE

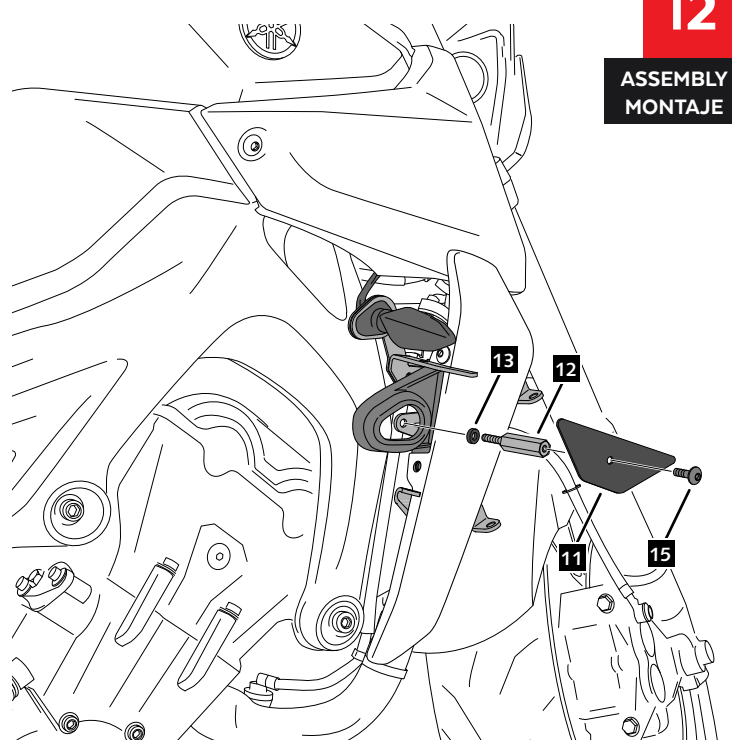

YAMAHA MT-09 '17-

INSTRUCCIONES DE MONTAJE - MOUNTING INSTRUCTIONS - MONTAGEANLEITUNG

13

ASSEMBLY
MONTAJE

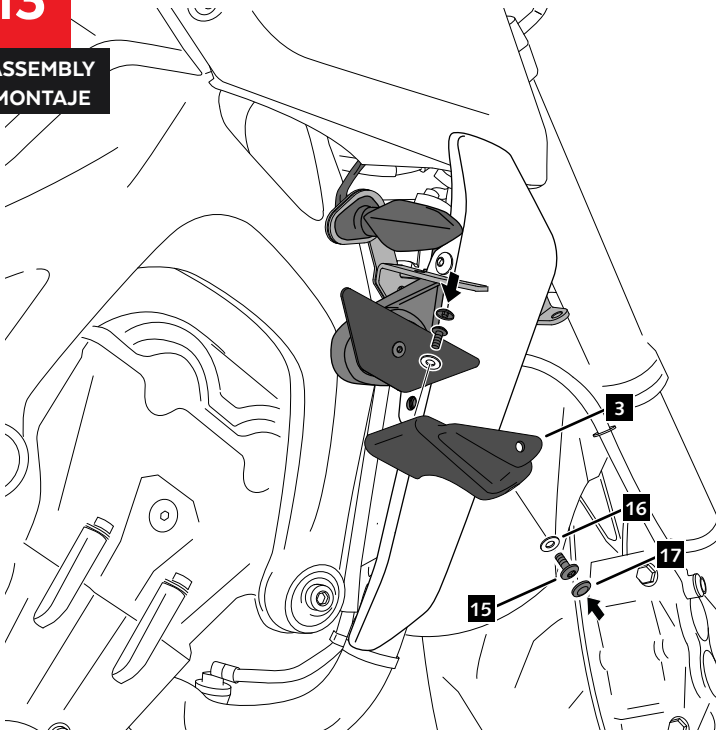

14

ASSEMBLY
MONTAJE

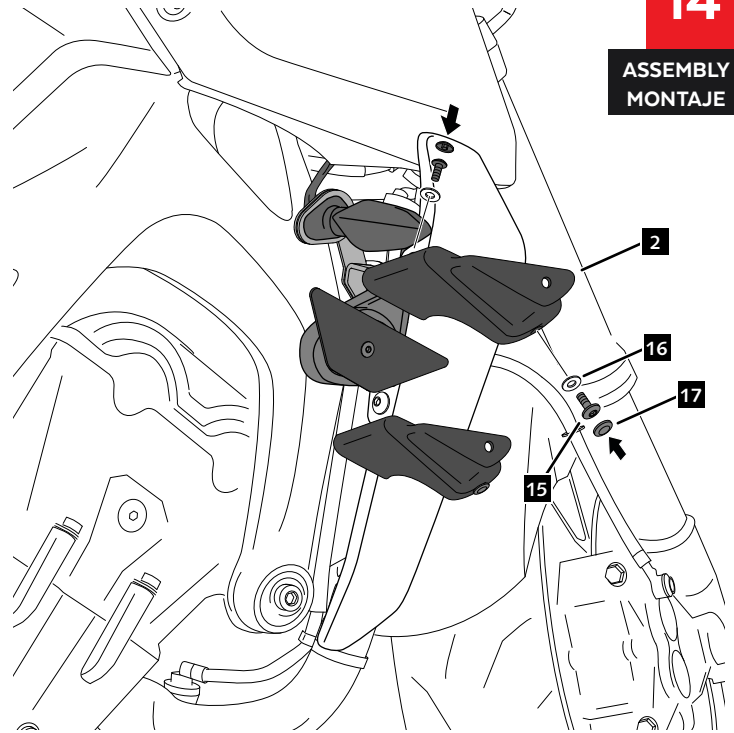

15.1

ASSEMBLY
MONTAJE

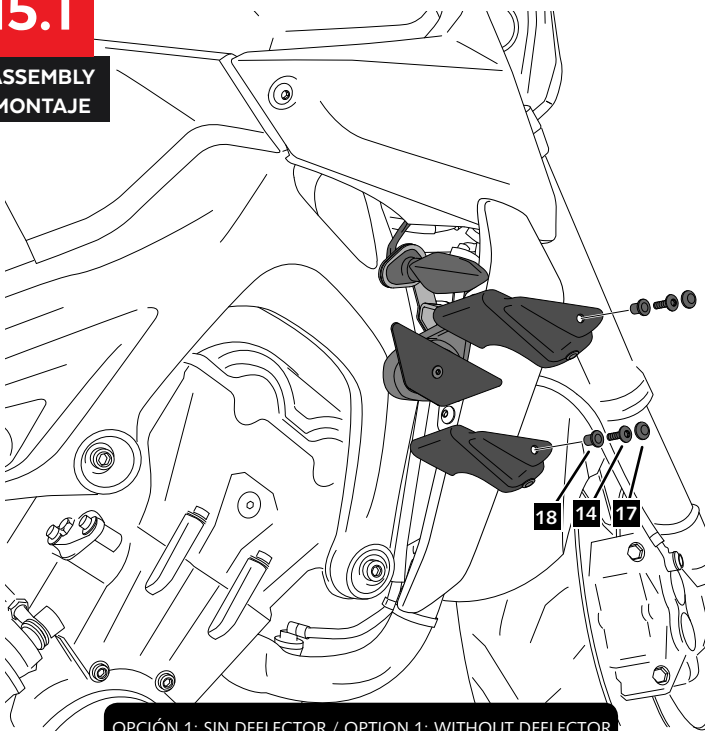

OPCIÓN 1: SIN DEFLECTOR / OPTION 1: WITHOUT DEFLECTOR

15.2

ASSEMBLY
MONTAJE

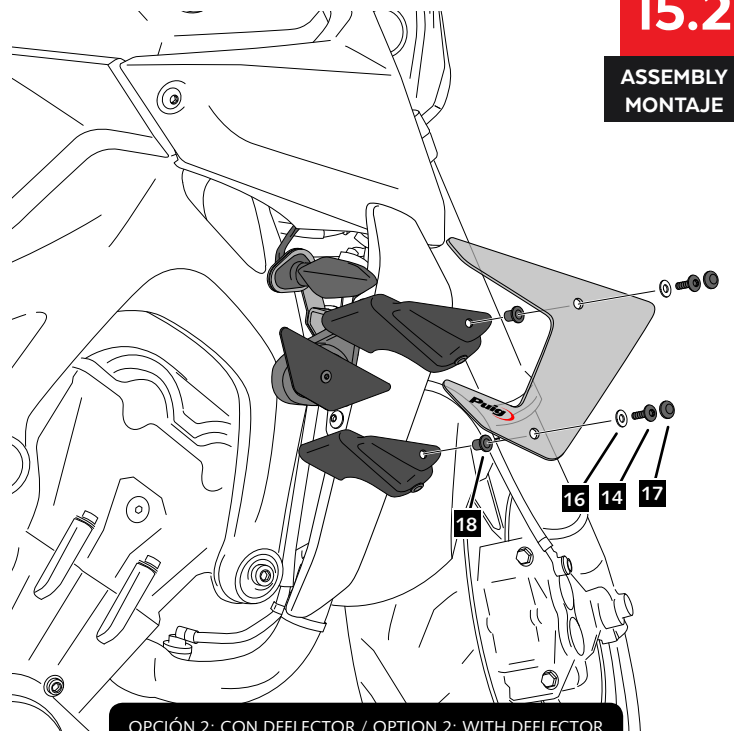

OPCIÓN 2: CON DEFLECTOR / OPTION 2: WITH DEFLECTOR