

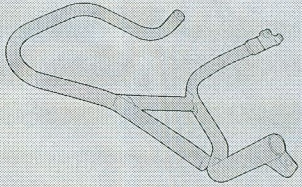







# TN3101 - KN3101

PARAMOTORE SPECIFICO - SPECIFIC ENGINE GUARD - PARE-CARTER SPECIFIQUE SPEZIFISCHER STURZBÜGEL - DEFENSA DE MOTOR ESPECÍFICA

## SUZUKI DL650 V-STROM L2-L3 (2011-2013)

N°	Descrizione	Caratteristiche	Codice	Quantità	
1	Paramotore - Engine Guard Pare-carter - Sturzbuegel Defensa De Moto	-	-	2 (Dx:Sx)	
2	Supporto - Support Support - Halter Soporte	GL916	-	2	
3	Nipples	-	347TN	1	
4	Supporto - Support Support - Halter Soporte	TCEI M8x35	835TCEI	9	
5	Vite - Screw Vis - Schraube Tornillo	TSCEI M8x20	820TSP	2	
6	Guarnizione - Gasket Joint D'étanchéité - Dichtung Junta	-	Z2161	2	
7	Rondella - Washer Rondelle - Scheibe - Arandela	Ø8	8RON	1	
8	Coprivite - Screw Cap Cache Vis - Stopsschraube Tapa Tornillo	Ø8	Z801	8	
9	Distanziale - Spacer Entretoise - Distanzstueck - Distanciado		V009	1	

# TN3101 - KN3101

PARAMOTORE SPECIFICO - SPECIFIC ENGINE GUARD - PARE-CARTER SPECIFIQUE SPEZIFISCHER STURZBÜGEL - DEFENSA DE MOTOR ESPECÍFICA

## SUZUKI DL650 V-STROM L2-L3 (2011-2013)

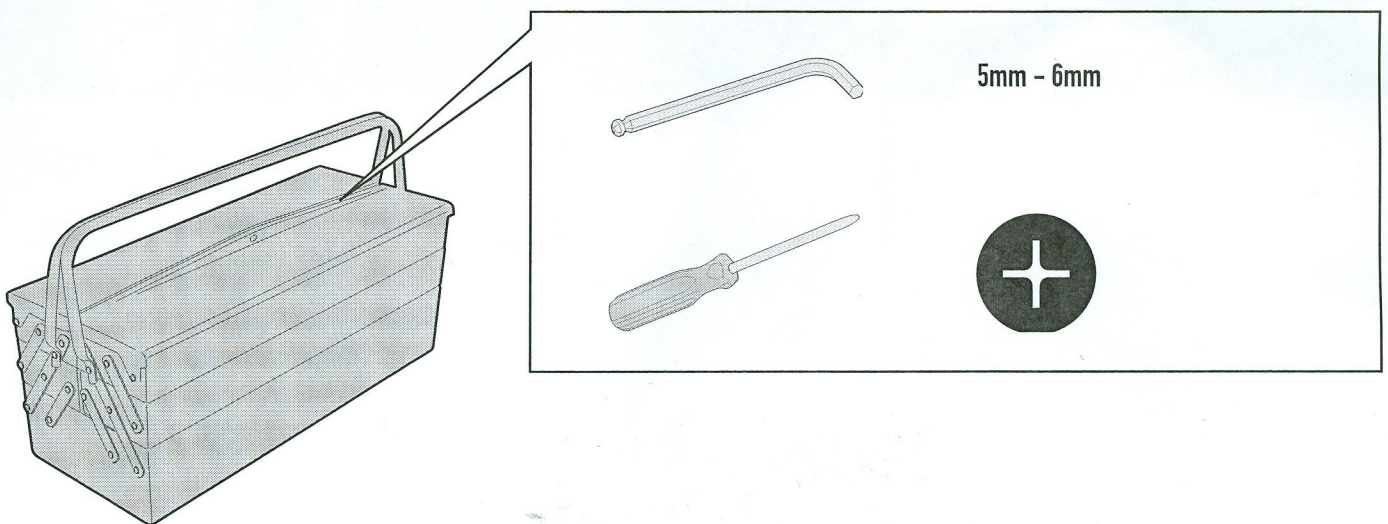

# TN3101 - KN3101

PARAMOTORE SPECIFICO - SPECIFIC ENGINE GUARD - PARE-CARTER SPECIFIQUE SPEZIFISCHER STURZBÜGEL - DEFENSA DE MOTOR ESPECÍFICA

## SUZUKI DL650 V-STROM L2-L3 (2011-2013)

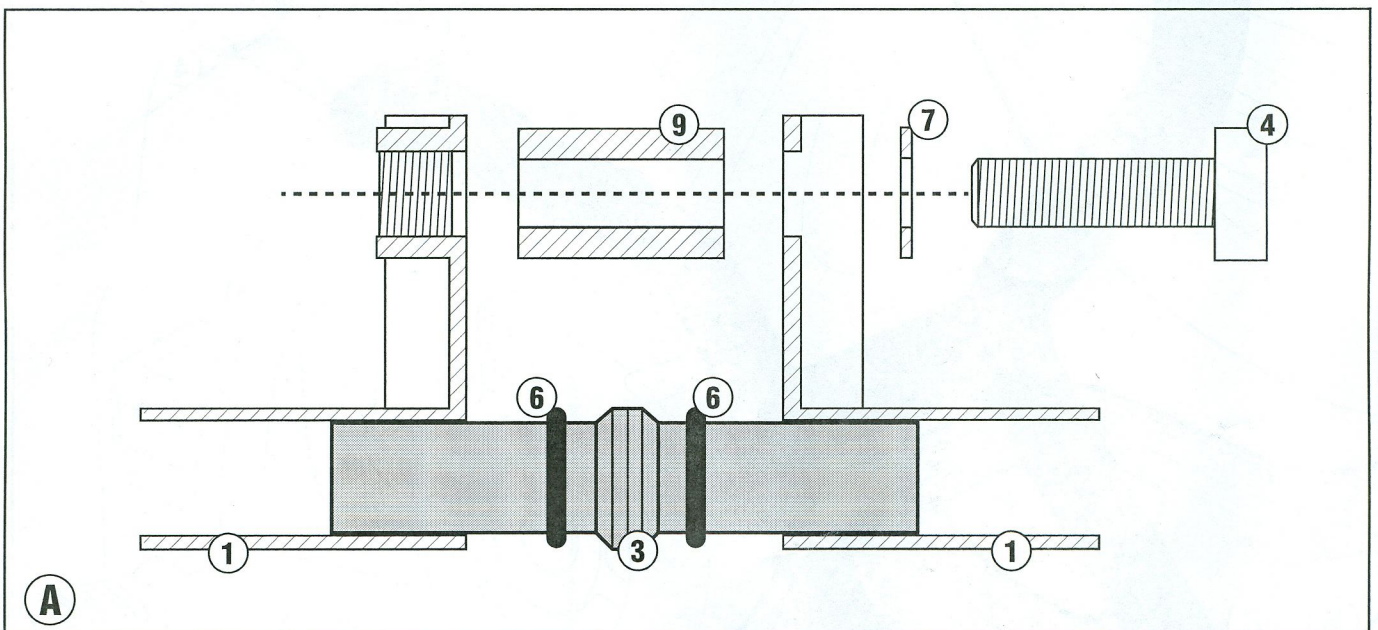
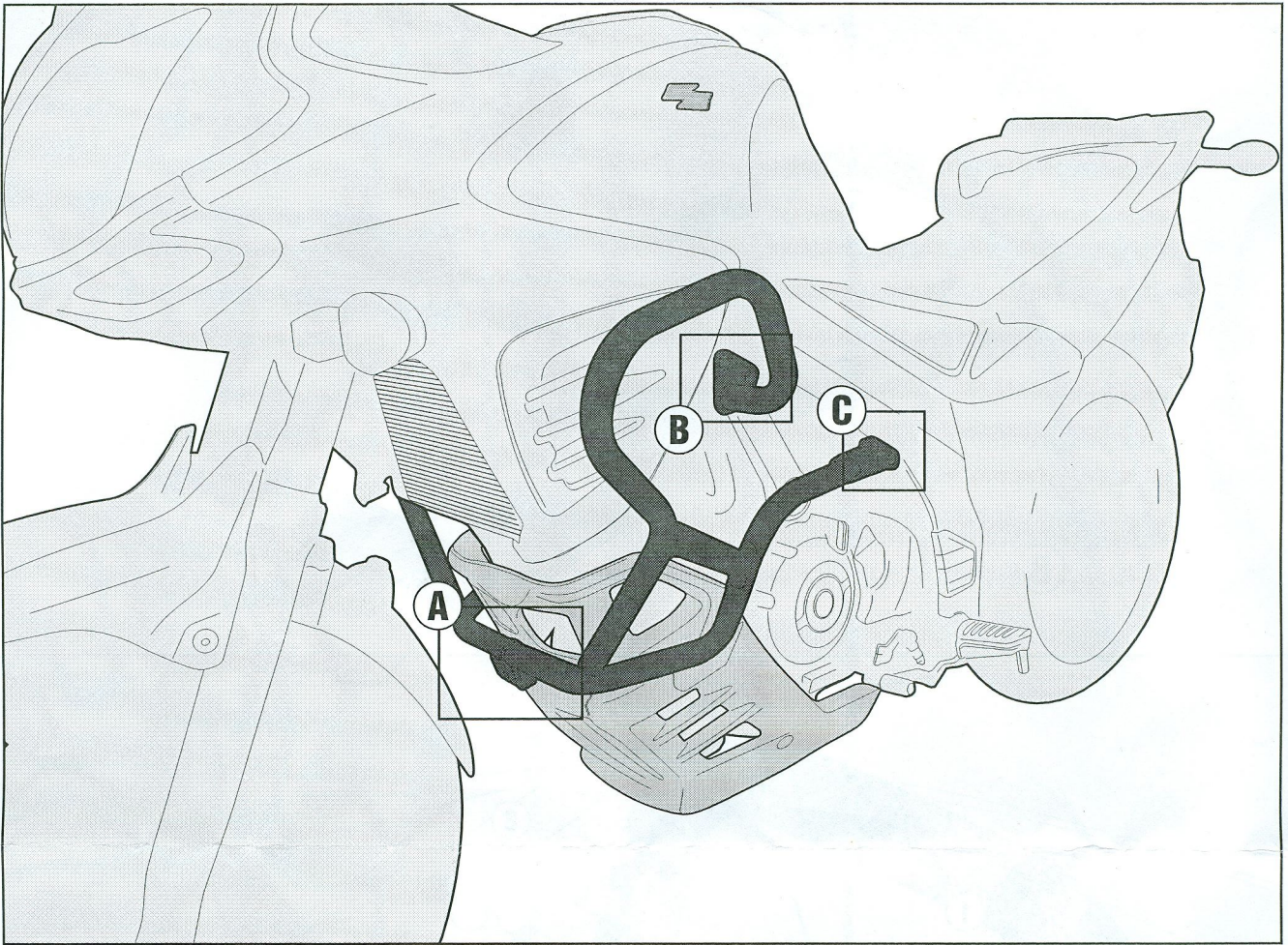

# TN3101 - KN3101

PARAMOTORE SPECIFICO - SPECIFIC ENGINE GUARD - PARE-CARTER SPECIFIQUE SPEZIFISCHER STURZBÜGEL - DEFENSA DE MOTOR ESPECÍFICA

## SUZUKI DL650 V-STROM L2-L3 (2011-2013)

