

# TN7708 - KN7708

## PARAMOTORE SPECIFICO - SPECIFIC ENGINE GUARD - PARE-CARTER SPECIFIQUE SPEZIFISCHER STURZBÜGEL - DEFENSA DE MOTOR ESPECÍFICA - PARAMOTOR ESPECÍFICO

### KTM DUKE 790 (2018)

N°	Descrizione	Caratteristiche	Codice	Quantità
1	Paramotore - Engine Guard Pare-carter - Sturzbuegel Defensa De Moto - Paramotor	-	GNB2187DXV GNB2187SXV	2(Right; Left)
2	Vite - Screw Vis - Schraube Tornillo - Parafuso	TCEX M10x50	1050TCEX	1
3	Vite - Screw Vis - Schraube Tornillo - Parafuso	TCEX M10X90	1090TCEX	2
4	Vite - Screw Vis - Schraube Tornillo - Parafuso	TCEX M10X80	1080TCEX	1
5	Vite - Screw Vis - Schraube Tornillo - Parafuso	TCEX M10X60	1060TCEX	1
6	Rondella Inox - Stainless Steel Washer Rondelle Inox - Rostfreie Unterlegscheibe Aus Stahl Arandela Inox - Arruela Lisa De Aço Inox	Ø10	10RONSX	5
7	Distanziale - Spacer Entretoise - Distanzstueck Distanciador - Espaçador	Ø16x40 Foro 12mm	C16L40F12FET	2
8	Distanziale - Spacer Entretoise - Distanzstueck Distanciador - Espaçador	Ø16x12 Foro 12mm	C16L12F12FET	1
9	Distanziale - Spacer Entretoise - Distanzstueck Distanciador - Espaçador	Ø20x22 Foro 10,5mm	C20L22F10,5T	2
10	Distanziale - Spacer Entretoise - Distanzstueck Distanciador - Espaçador	Ø22x6 Foro 10,5mm	C22L6F10,5T	1
11	Distanziale - Spacer Entretoise - Distanzstueck Distanciador - Espaçador	Ø22x5 Foro 10,5mm	C22L5F10,5T	1
12	Distanziale - Spacer Entretoise - Distanzstueck Distanciador - Espaçador	Ø18x30 Foro 10,5mm	C18L30F10,5T	1
13	Distanziale - Spacer Entretoise - Distanzstueck Distanciador - Espaçador	Ø20x5 Foro 11,5mm	C20L5F11,5T	1
14	Componenti Originali - Original Parts Parties Originales - Original Bauteile Componentes Originales - Componentes Origin	-	-	-

# TN7708 - KN7708

PARAMOTORE SPECIFICO - SPECIFIC ENGINE GUARD - PARE-CARTER SPECIFIQUE SPEZIFISCHER STURZBÜGEL - DEFENSA DE MOTOR ESPECÍFICA - PARAMOTOR ESPECÍFICO

## KTM DUKE 790 (2018)

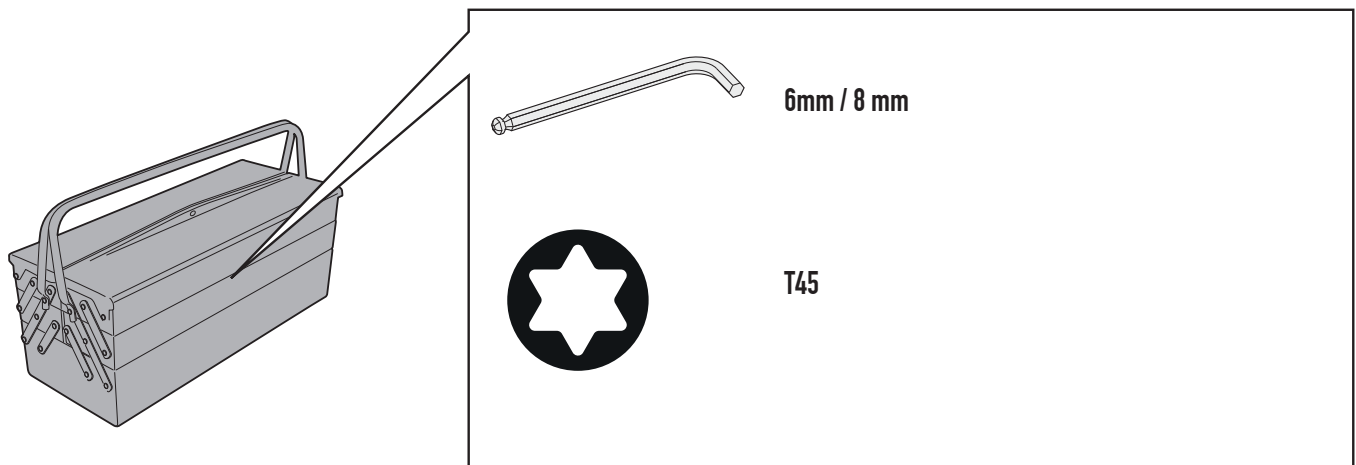
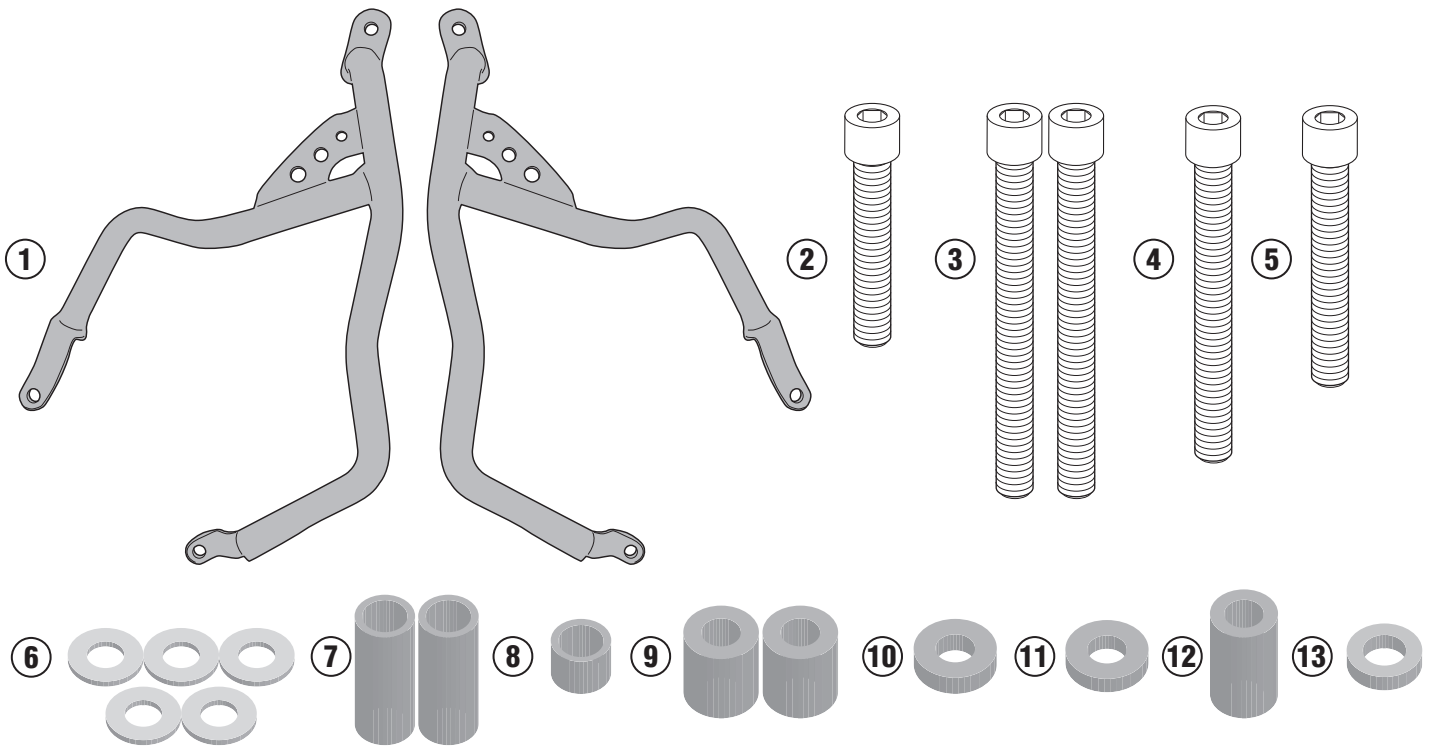

# TN7708 - KN7708

PARAMOTORE SPECIFICO - SPECIFIC ENGINE GUARD - PARE-CARTER SPECIFIQUE SPEZIFISCHER STURZBÜGEL - DEFENSA DE MOTOR ESPECÍFICA - PARAMOTOR ESPECÍFICO

## KTM DUKE 790 (2018)

### RIGHT SIDE

REMOVE

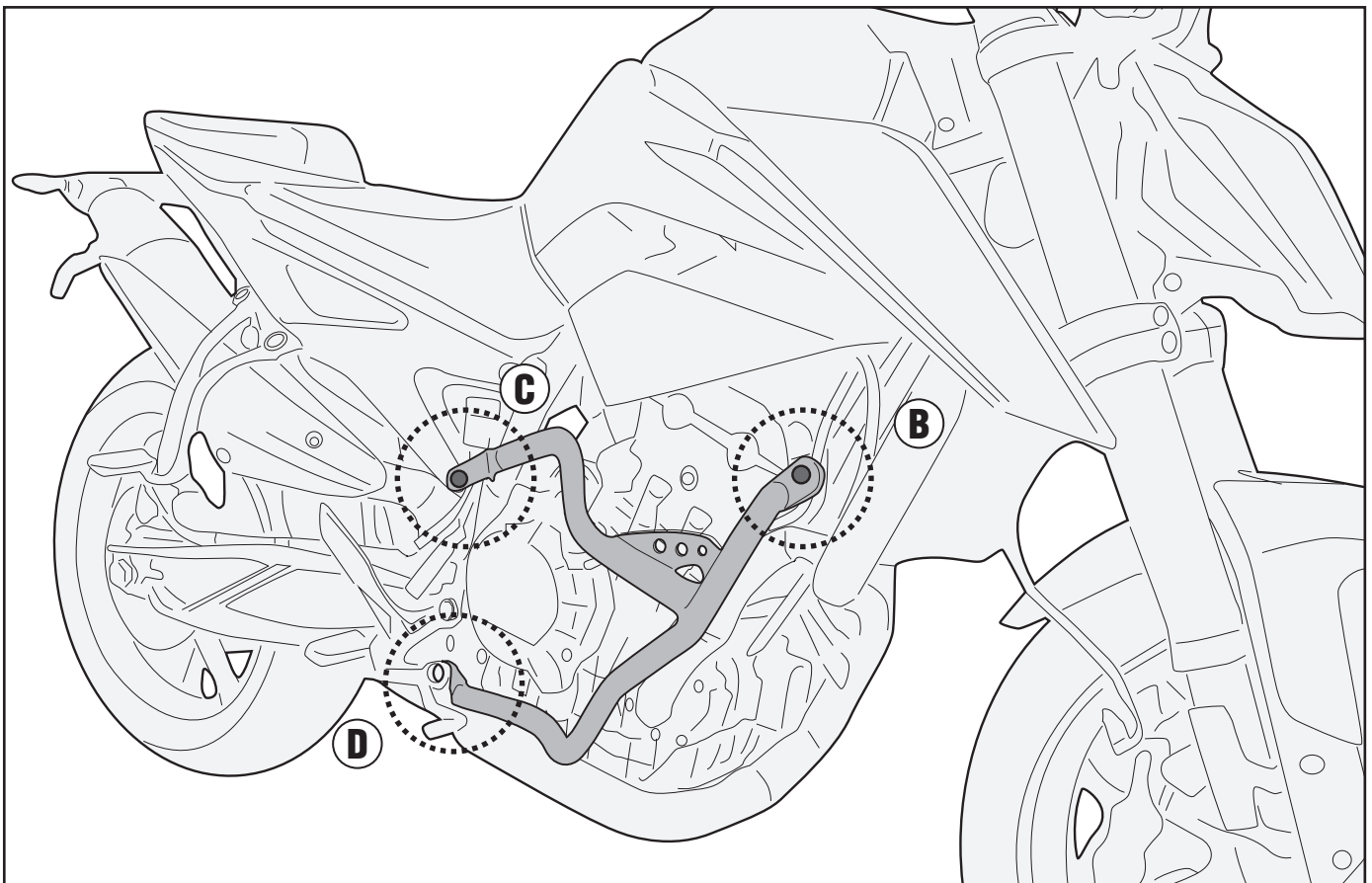
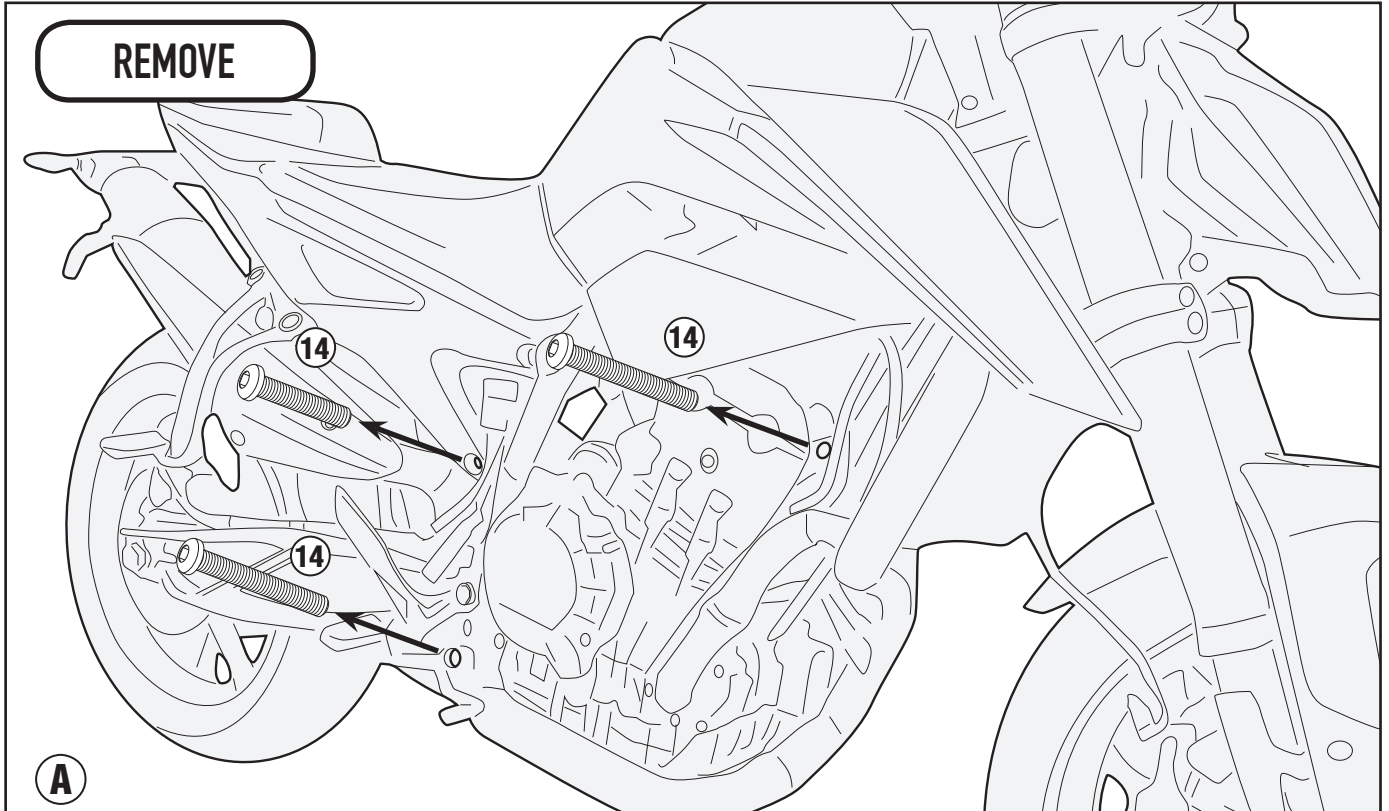

ISTRUZIONI DI MONTAGGIO - MOUNTING INSTRUCTIONS  
INSTRUCTIONS DE MONTAGEBAUANLEITUNG  
INSTRUCCIONES DE MONTAJE - INSTRUÇÕES DE MONTAGEM

# TN7708 - KN7708

## KTM DUKE 790 (2018)

PARAMOTORE SPECIFICO - SPECIFIC ENGINE GUARD - PARE-CARTER SPECIFIQUE SPEZIFISCHER STURZBÜGEL - DEFENSA DE MOTOR ESPECÍFICA - PARAMOTOR ESPECÍFICO

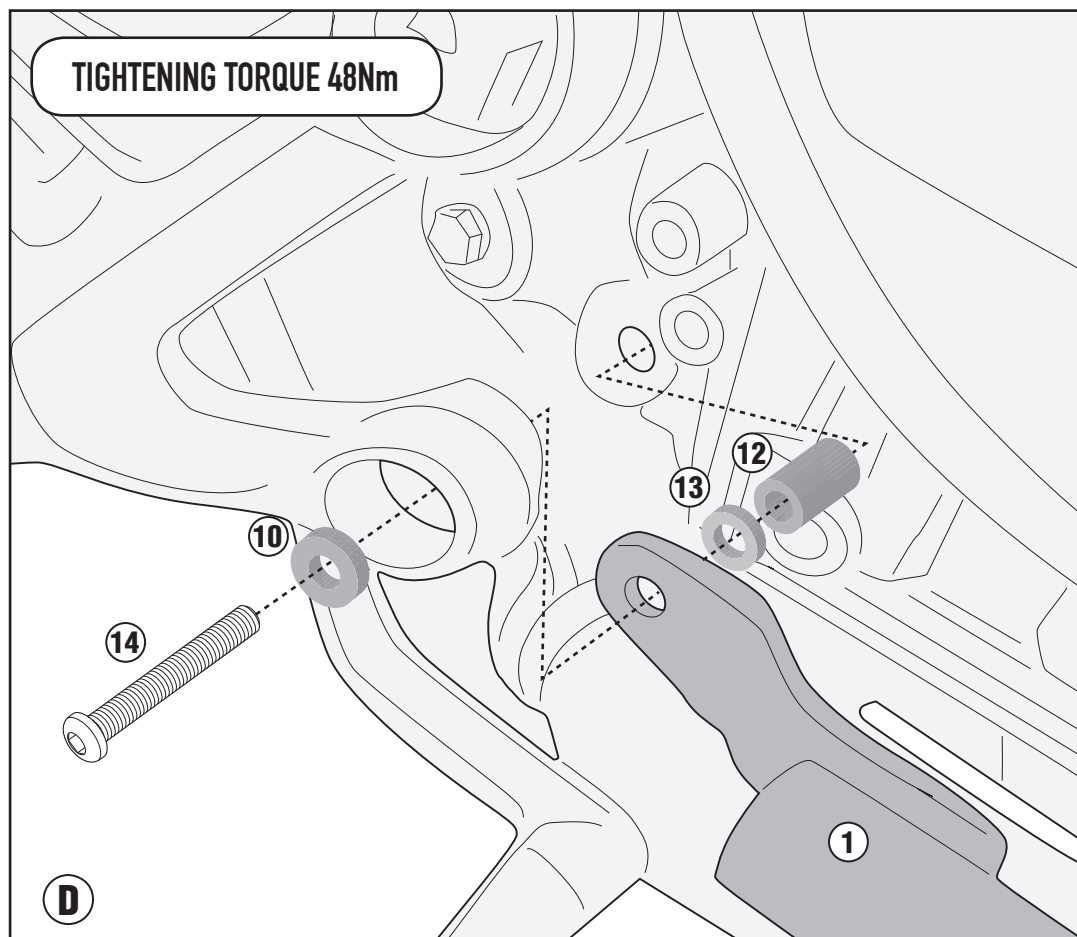
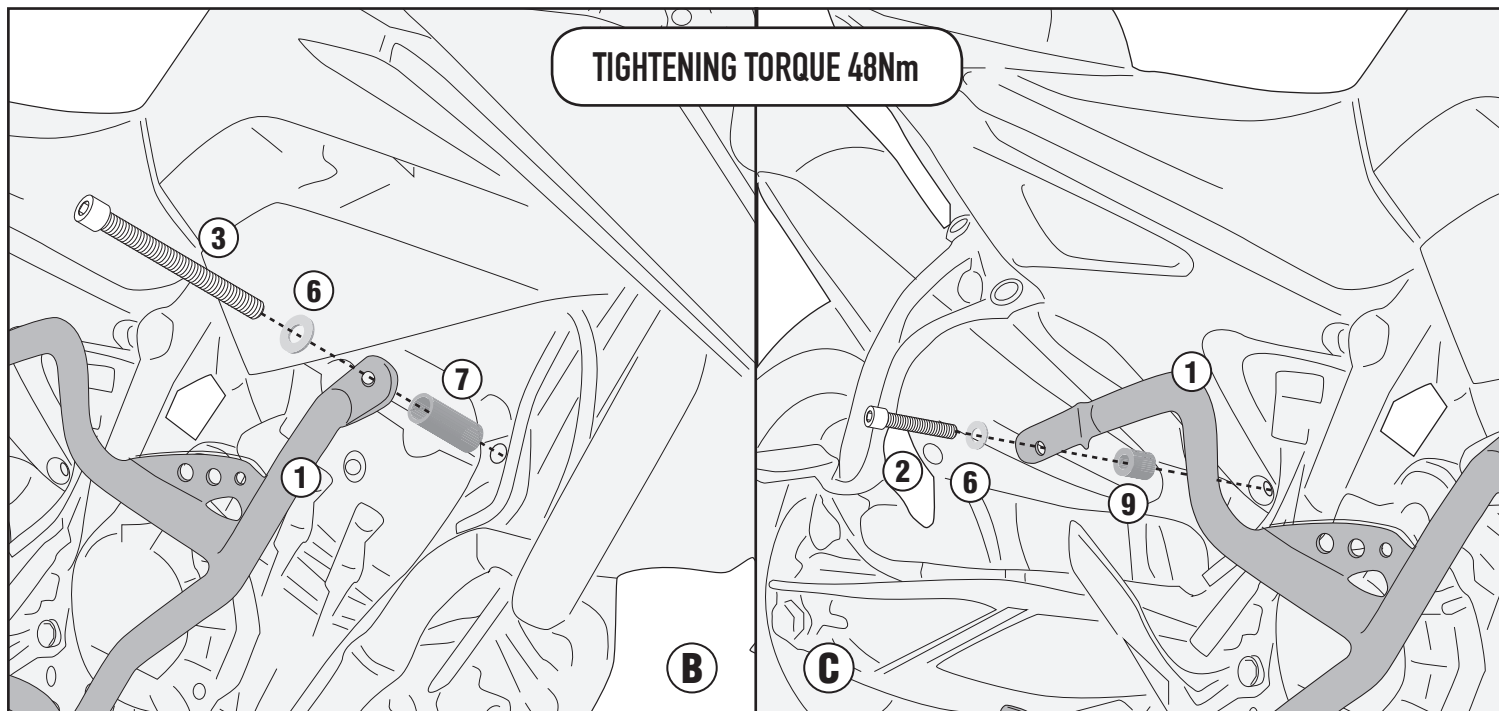

# TN7708 - KN7708

## KTM DUKE 790 (2018)

PARAMOTORE SPECIFICO - SPECIFIC ENGINE GUARD - PARE-CARTER SPECIFIQUE SPEZIFISCHER STURZBÜGEL - DEFENSA DE MOTOR ESPECÍFICA - PARAMOTOR ESPECÍFICO

### LEFT SIDE

REMOVE

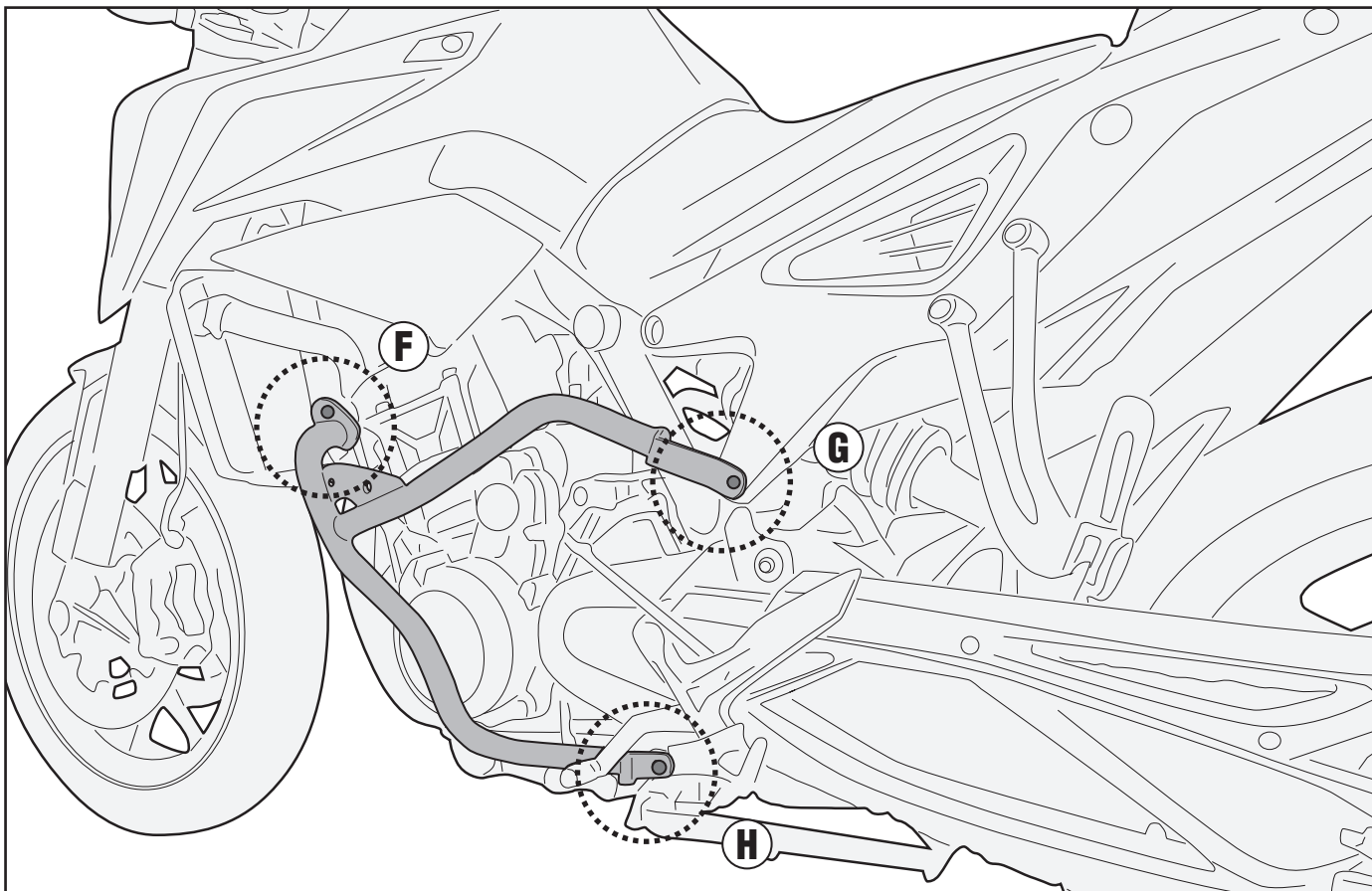
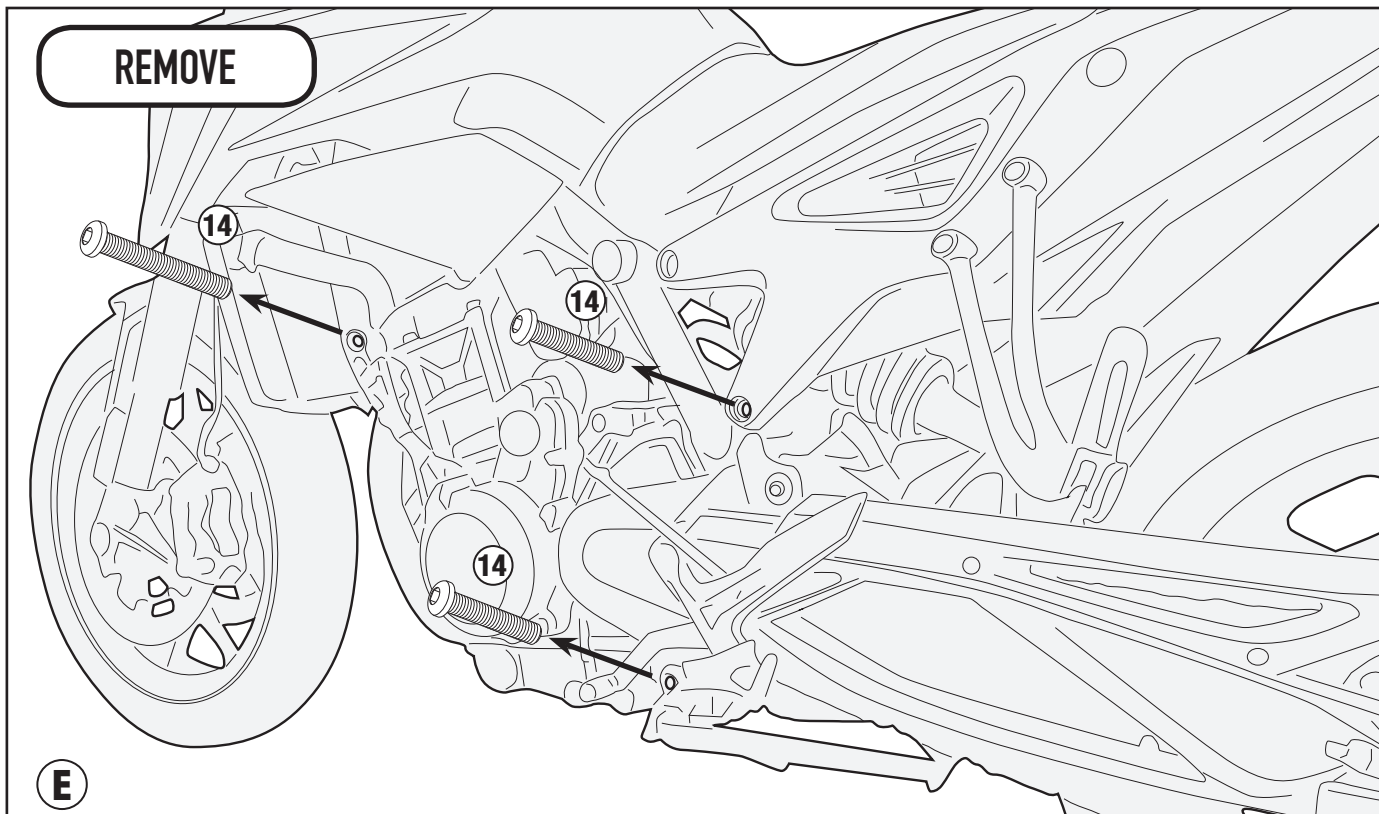

ISTRUZIONI DI MONTAGGIO - MOUNTING INSTRUCTIONS  
INSTRUCTIONS DE MONTAGE/BAUANLEITUNG  
INSTRUCCIONES DE MONTAJE - INSTRUÇÕES DE MONTAGEM

# TN7708 - KN7708

## KTM DUKE 790 (2018)

PARAMOTORE SPECIFICO - SPECIFIC ENGINE GUARD - PARE-CARTER SPECIFIQUE SPEZIFISCHER STURZBÜGEL - DEFENSA DE MOTOR ESPECÍFICA - PARAMOTOR ESPECÍFICO

